

Article number: 20955461

Description: E+G Levelling foot
GN 342.1-40-M12-SV

Measures

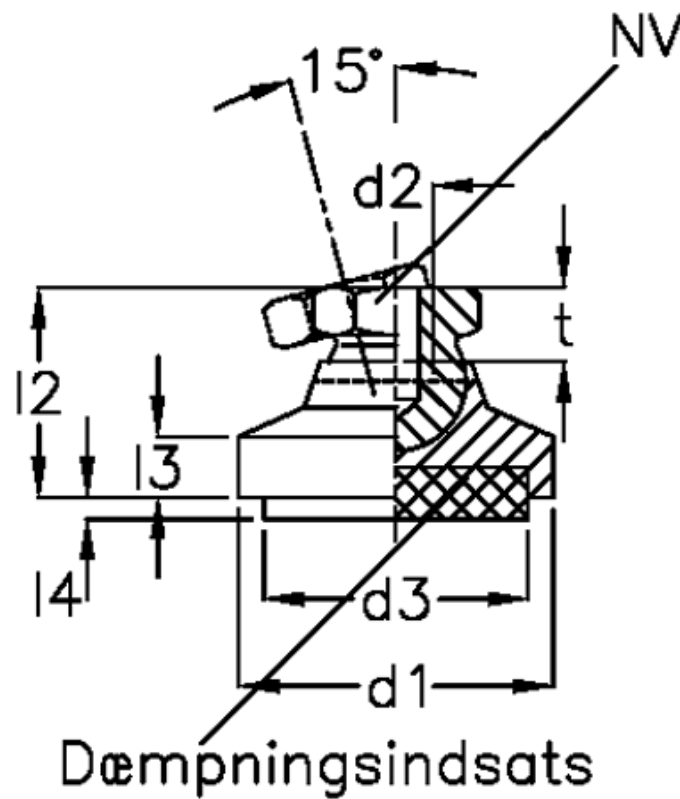

Area(m ²) damping insert	= 1134	l4 compression 0.6 N/mm ²	= 3.9
d1	= 40	Load (N) by compression 0.4 N/mm ²	= 450
d2	= M12	t	= 11.5
d3	= 38		
l2	= 30.0		
l3	= 9.5		
l4 compression 0 N/mm ²	= 6.0		
l4 compression 0.4 N/mm ²	= 4.8		